

estelon

from Alfred + Partners

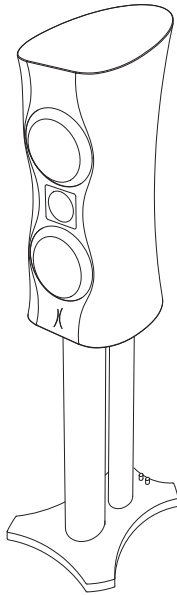

Model: XC

*Designed
by Alfred Vassilkov*

Serial Number _____

Your ESTELON loudspeakers have passed our quality control:

- Technical test passed.

- Listening test passed.

Alfred Vassilkov
Head of Research and Development,
Alfred & Partners

Table of Contents

1. Introduction.....	4
1.1. Alfred & Partners.....	4
1.2. Estelon XC.....	6
2. Specifications.....	9
3. Unpacking Instructions.....	11
4. Set-up.....	14
4.1. Initial positioning in the room.....	14
4.2. Wiring.....	15
4.3. Break-in period.....	15
4.4. Recommendations from Alfred Vassilkov.....	15
5. Taking care of your Estelon speakers.....	16
6. Warranty – Technical Services.....	18

1. INTRODUCTION

1.1. Alfred & Partners

Alfred & Partners, the Tallinn based design studio and think tank, is not simply a business but a dedication, a dedication to a single, heartfelt idea – the production of **Instruments**, Sound Diffusers, Sculptures – capable of unveiling the rich, emotional tapestry of music in a personally involving way.

For more than 25 years, the designer and founder, **Alfred Vassilkov**, has been designing loudspeakers – achieving success both in design and patents – with developed products, in Europe. A decision was made – that to establish his own brand based on his gathered experience and knowledge.



The designer and founder, Alfred Vassilkov

Such dedication carries with it the implicit responsibility of a wholly uncompromising approach to audio design. Pride of craftsmanship shares equal footing with sonic innovation. Their visionary achievements, their quest for musical truth, continuously pushing the

envelope – the result is a product line that offers unrivalled musical revelation packaged in designs of unparalleled beauty.

More importantly, we hope that their efforts can, in some small way, offer a key that assists listeners in unlocking the vast structure of emotion that is – **music**.



For **Estelon**, the new brand, the visionary development started in 2006 when Alfred started to analyze materials and technologies for producing cabinets with streamlined shapes that could not only reproduce the best sound but also assimilate into an interior, with their elegant “**sculpture**” look. Years of work had led him to a proprietary, crushed marble based composite. The material having excellent stiffness and damping factors, as well as technical features that allowed for the creation of cabinets with a design that enhances the sound reproduction capability of the system as a whole.

The special **E-lon** shape of the loudspeaker creates **ideal** conditions for sound reproduction. Its rounded form excludes corner reflections. A narrowing of the tweeter area – the front panel sculpted – to achieve 0 phase at the listening point, while its larger radiuses maintain their excellent influences on the direction diagram. The cabinet becomes wider and deeper at its base for both stability and to allow for the volume required for effective low frequency reproduction.

Finally, every loudspeaker produced must pass Alfred & Partners extreme level of quality control – each pair of loudspeakers is assembled, tuned and then listened to individually. AND lastly, all the products are handmade in Estonia, to their exacting standards.

1.2. Estelon XC

Chief among the physical design elements is the use of the E-lon cabinet form, having been developed and honed over a five year period – its design and construction allow it to easily couple with even difficult room acoustics.

Inspired by the development of the Estelon XA, Alfred Vassilkov's first tribute to the Estelon brand, the Estelon XC offers much of the XA's qualities in a smaller and less expensive full range monitor. Exceptionally wide imaging, deep sound staging and thrilling life like dynamics are a hallmark of Estelon loudspeakers and the XC is no exception. By combining these legendary sonic attributes with a musically detailed presentation, Estelon has again redefined the standard reference in a small speaker design. Cosmetically, like its full-sized, floor-standing brother, the diminutive XC features the same seductively shaped E-lon cabinet and multi coated lacquer finish. When high-resolution performance is required, the Estelon XC is the ideal choice for listening rooms where the larger Estelon XA would be impractical or excessive.

The dedicated floor stands, a strong but combination duraluminum and steel are directly couple to the Estelon XC's base, raising the speakers to the optimal listening point, while providing adjustable rake via the spikes. The XC is far more than simply speaker drivers in a cabinet. It is a genuine musical instrument in its own right. One that, when carefully integrated into system and room, is capable of connecting the listener to music in a most profound way. Everything expressed naturally and simply with balance, order and measure. It possessed an eminently musical temperament that is immediately evident upon your first and each subsequent listening experience.

Many years have passed since the genesis of the Estelon project and much has been learned during this visionary period – embodying all the visionary achievements – the roots and the choices that

have evolved into the Estelon sound. With the XC, the most beloved element of Estelon products has been reaffirmed: Simplicity. The “minimal” electrical second order crossovers, the raffinated mix of other elements as drivers and acoustic enclosure, has allowed Estelon to find again, trusted and confirmed qualities, a rediscovering and refinement of old but never obsolete design principles, technological principles that are the true expression of Estelon’s sonic esthetics.

Cabinet Design – The E-lon shape, its evolution, choices of material and time-honored construction techniques – a special casting process, the use of a proprietary marble based composite and the extensive use of sub-structural stiffening spars breaks up resonance nodes and creates an internal acoustic chamber of non-parallel side-walls that is all but immune to unwanted standing waves that can cause a colored sound. During the final hand-assembly process each speaker is individually tuned to maintain uniformity from unit to unit. Unusual in its defined form, the results of this cabinet construction allows it to be easily couple with even difficult room acoustics – allowing bass to roll effortlessly into the listening space. Here, the form is more tightly tailored and the reduction in overall scale works to its advantage allowing it to be easily integrated into a variety of listening spaces.

Transducers – Meticulously fitted, the drive units employed are the highest expression of transducer design. The two 173 mm German made Accuton bass-midrange drivers are a sophisticated design with particular attention paid to the 32mm titanium voice coil former and the surrounding air gap to provide maximum freedom from dynamic compression in conjunction with the use of a special ultra stiff ceramic dome – valued for its midrange neutrality, are mated to their own acoustic enclosure. All moving elements of the individual driver are ventilated for “resonance free” response. The 30 mm high frequency driver has ultra hard ceramic dome. Anti-resonant cutout

fills in the ceramic dome provide for damping of the dome resonance. A neodymium overhung motor design with vented aluminium voice coil former guarantees low energy storage and excellent heat transfer. The soft fabric surround and ferrofluid with high viscosity center the moving parts with distinctive linearity. Each drive unit is “broken in” by running signal through them for several hours before being fitted into the cabinet, and finally the speakers’ individual tuning.

Crossover – A “minimalist design” 2nd order crossover is used mainly for the natural sound such a design affords. All component parts used are of the highest quality and were chosen through extensive listening tests based on subjective musicality – Mii Teflon hybrid capacitors, Kubala-Sosna internal wiring. Often, seemingly minor changes greatly affected the final sound! Such attention to detail is readily apparent upon first hearing – the result – a totally coherent signal path, a claim proved out based from extensive A/B listening.

Finish – Just as in the making of a great musical instrument, the finish has a profound effect on the final sound! After casting, the proprietary marble based composite is allowed to age, prior to the application of a multi layer internal resonance compound. Only after this time consuming process does the preparation of the surface of the cabinet commence. Manual labor – hand sanding and sealing, layer upon layer, applied using an elaborate and time-consuming procedure. And finally the multiple coats of the lacquer finish is applied – hand sanding accompanying each finishing coat. Final polishing – to a mirror-like finish, again, is done by hand. The Estelon XA is offered in a choice of liquid gloss or matte finishes.

2. SPECIFICATIONS

Woofers:	2 x 7" Accuton, ceramic membrane
Tweeter:	1.2" Accuton, ceramic inverted dome
Internal Wiring:	Kubala-Sosna
Frequency Response:	45-28 000 Hz
Power Rating:	150 W
Min. Amplification Power:	20 W
Nominal Impedance:	8 ohms
Sensitivity:	90 dB/2.83 V
Height:	1260 mm with stand / 724 mm without stand (28.5" / 49.6")
Width:	332 mm with stand / 262 mm without stand (10.3" / 13")
Depth:	394 mm with stand / 367 mm without stand (14.4" / 15.5")
Net Weight:	42 kg per piece with stand (93 lbs)
Shipping Weight:	70 kg per piece (154 lbs)

Dimensions in Millimeters:

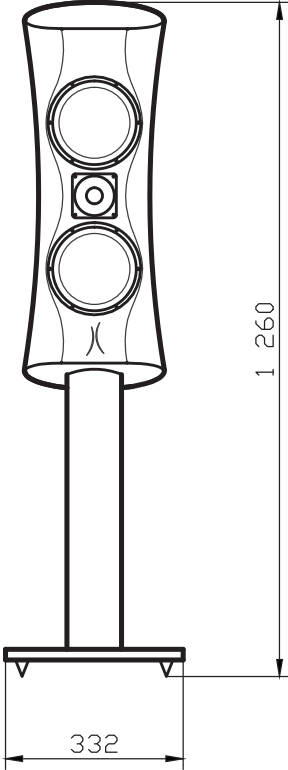
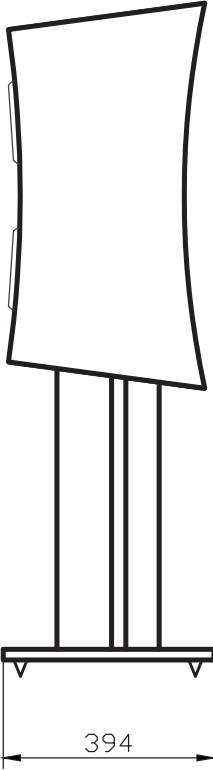

3. UNPACKING INSTRUCTIONS

Your Estelon loudspeakers come packaged individually in 2 separate flight cases – we strongly recommend keeping these cases for possible future use / transport. Due to the substantial weight and slippery surface of the loudspeakers we suggest that two persons assist in the unpacking and positioning of them for listening.

Contents of the two flight cases:

- 2 loudspeakers
- 1 Accessories box
 - 2 sets of spikes (8 pieces)
 - 1 user's manual
 - 2 pairs of gloves
 - 1 polishing cloth
 - 1 impregnated polishing cloth
(supplied only with liquid gloss finish)

For unpacking, please follow the instructions described below and as shown in the drawings:

1. Unlock / Open all four locks on the flight case cover.
This should only be done with the speaker / flight case in a horizontal position.
2. Carefully lift the cover off the flight case and put it aside.
3. Now, take the speaker out from the flight case. We recommend two persons to do this procedure: one person holding the speaker, the second person supporting the stand. The speaker and the stand come preassembled. Lift the speaker and the stand together as one – do not use the stand to lift up the head unit/speaker as you may cause

1

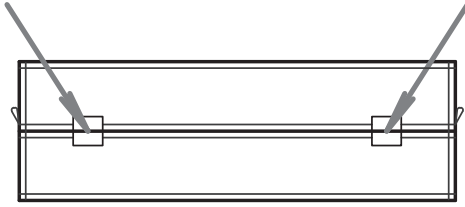

2

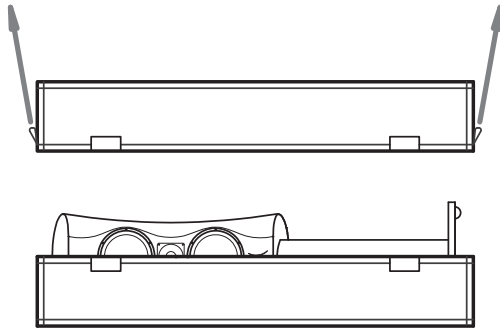

3

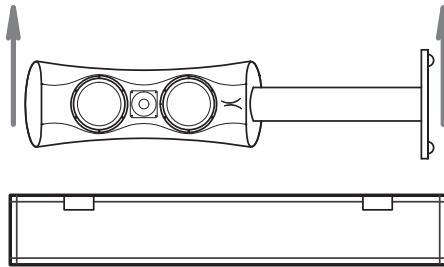

damage. After taking the speaker out from the case put it in upright position as showed on picture 4.

4. At this time, please put on the gloves that you find included in the case. Now, with the speaker in upright position, carefully remove the cloth bag from the speaker and put it to the desired position in your room. We recommend keeping the speakers on transport spikes during the initial set-up. Once the final position has been located, it is time to replace the transport spikes with the enclosed spikes. Doing one side at a time, carefully tilt the speaker to one side and replace the transport spikes with the enclosed spikes. Please *retain* the transport spikes, once removed, in the event that repackaging is required.

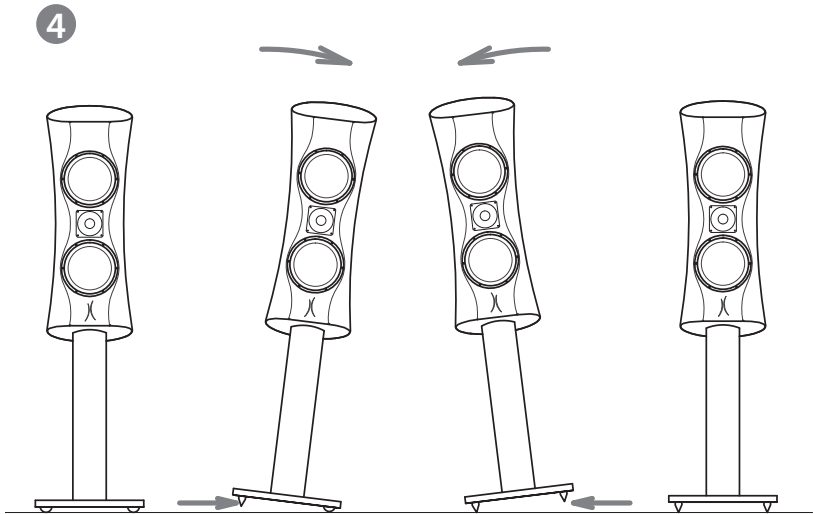

4. SET-UP

4.1. Initial positioning in the room

Model XC – Suggested room size 16-45 m².

When positioning the speakers in your room, if possible, it is desirable to allow for “free” space around the speakers so as to assist in minimizing sound reflections from walls, furniture etc. This will help in achieving correct tonality, realistic imaging, focus and dynamics. The recommended minimum distance between the speaker and the nearest reflection point is 1.2 m (3.6 ft).

A “smooth” back wall will minimize imaging distortions. The distance between the back wall and the speaker should not be less than 0.6 m (1.8 ft), the distance from the tweeter to the back and side walls must not be too similar.

Listening point: the distance between your ears and the floor should be approx. 1 m (3 ft), while the distance between the listener and the speakers should be similar to the distance between the two speakers.

The positioning of the speakers in the room must be symmetrical for achieving a balanced sound stage – this is very important in a narrow room. Expect the distance between the speakers to be approximately 2.5 - 5 m, depending on the size of the room and its reverberation characteristics.

The recommended speaker’s direction is approximately 7°, off axis, towards the listening position.

4.2. Wiring

When connecting the speaker to the amplifier please make sure that the amplifier is in an off position.

Connect the speaker cable to the pole terminal on the back of

the speaker: speaker terminal „+“ with the amplifier terminal „+“ and „-“ with „-“.

For signal flow, please follow the direction marked on the cable or in the cable manufacturer’s instruction. Typically, the signal flow will be in the same direction as the labeling / writing on the cable.

4.3. Break-in period

Although your Estelon speakers had an initial break-in at the factory, due to shipping conditions – pressure/temperature changes that they may have incurred, the speakers will need to go through an additional break-in process before their final set-up.

All the mechanical and electrical connections will stabilize naturally after playing a continuous music signal for approx. 24 hrs – e.g. use a digital source in the repeat mode. After the initial break-in period you can start setting-up the sound according to the recommendations from Alfred Vassilkov.

Please note that the speakers will have reached their optimum level of performance after playing in your system for 300-400 hrs.

4.4. Recommendations from Alfred Vassilkov for the set-up

The set-up of the sound consists of the balancing of many different parameters: tonality, bass accuracy, focus, stage imaging, deepness etc. This process is time consuming and depends on the listener’s experience or the qualification of the set-up specialist. Proper set-up will maximize your Estelons’ performance.

During the final set-up small changes may be made to the initial chosen position, e.g. moving the speakers 10 cm towards the front wall, then maybe a little bit inward and outward. Please evaluate the sound carefully every time you make a small change in the positioning.

Then continue, making smaller changes in the positioning and evaluate again, until the proper position with a balanced, natural sound is found. We suggest that you test, listen, with different music styles so as to avoid specific accents.

When changing the position of your speakers please keep in mind that:

- Close proximity to the back wall and corners will reinforce, enhance, the bass performance.
- A shorter distance between the two speakers, will create a better focus and deeper imaging, but will at the same time reduce the sound width.
- Pointing the speakers inward minimizes reflections from the side walls but has an impact on the imaging.

Once you have located the proper position replace the wheels with the spikes included in the case. You can adjust the angle, phase of the speaker to the listening point by changing the height of the spikes – rear.

For critical listening, please allow 30-60 minutes for the system to stabilize, each time you play the speakers.

When played at excessive volume you stand the risk of doing damage to the drivers.

5. Taking care of your Estelon speakers

The multicoated finishes applied to Estelon speakers are considered to be amongst the most advanced automotive finishes available. They are extremely strong and durable. In order to assist you in maintaining their stunning appearance, your Estelon loudspeakers come supplied, from the factory, with special cleaning / polishing cloths. Please take note – only dry cleaning is allowed – do not wash the speakers.

When the nature of a smudge / spot so necessitates, a soft moist cloth may be used to gently liquefy / remove smudges prior to a final finishing with the special cloths which accompany the speakers.

For the Liquid Gloss finish, please use only the polishing cloth included in the flight case. Be careful not to apply the polish to the loudspeaker drivers. The use of other materials can damage, scratch or destroy the finish.

More detailed information regarding the polishing clothes and information for obtaining additional product:

For the Liquid Gloss finish:

DuPont™ Sontara® Polish Cloth impregnated with Krytox®
Silicone-free

Impregnated with DuPont™ Krytox®, a high performance polish that gives a long-lasting shine and extra protection to paintwork

No additional wax or polish required

For the Matte Finish:

3M Perfect-it™ III High Performance Polishing Cloth

Item # 50486

Or other 3M Microfiber cloths

For additional information and guidance regarding cleaning / polishing materials, please contact your dealer or distributor.

6. ESTELON / ALFRED & PARTNERS – Technical Services

Alfred & Partners OÜ Five Year Limited Warranty Terms and Conditions

1. Limited Warranty – All ESTELON products purchased from authorized ESTELON dealers are covered by a limited 5-year non-transferable warranty granted by Alfred & Partners OÜ. This warranty includes all parts and labour charges as well as return-shipping charges (product owner is responsible for all shipping and insurance charges one-way to the ESTELON repair facility or ESTELON factory approved repair facility).

Upon receipt of an online registration Alfred & Partners OÜ warrants the purchased product to be free from manufacturing, materials, and workmanship defects for **five years** from the date of original purchase, subject to the following conditions. **Failure to register the ESTELON product within 30 days from original purchase will result in a warranty period of 90 days from the date of purchase.**

Customers should consult with their original ESTELON dealer or distributor for possible alternate repair instructions prior to contacting the ESTELON factory. Other ESTELON dealers or distributors may refuse from assisting the Customer under the limited warranty. BUT under any and all circumstances customers are welcome to contact our sales department, listed on our web site www.estelon.com, for service assistance.

This limited warranty is valid only in the country where the product was originally purchased. If the repair request that is covered under this warranty comes from another country then Alfred & Partners OÜ may request the Customer to compensate to Alfred & Partners OÜ additional costs arising from providing this limited warranty in another country than the country of original purchase.

This limited warranty shall not affect the statutory rights of the Customer.

2. Limited to Original Purchaser – This warranty is for the sole benefit of the original purchaser of the covered product, and may not be transferred to a subsequent purchaser of the product.

3. Conditions and Limitations – This warranty is subject to certain conditions and limitations, as follows. This warranty is void and inapplicable if the product has not been used in accordance with the instructions found elsewhere in the owner's manual, or if it has been mis-used or abused, damaged by accident or neglect, or in transport once in possession of the purchaser. The warranty is also deemed void if the product has been repaired, modified, or tampered with by anyone other than Alfred & Partners OÜ or its specifically authorized agents. Please Note – if the fasteners to the cover of the crossover area, those covered with multi coloured specialty epoxy seal, have been tampered with / the epoxy removed – the warranty will considered to be void.

This warranty does not cover defects due to accidents or similar causes arising after the risk for the product has passed to Customer, or normal deterioration, wear and tear.

4. Remedy – If this product contains a materials, manufacturing, or workmanship defect that cannot be repaired at the dealership where the product was purchased, it must be packed in original packaging and returned to Alfred & Partners OÜ via insured freight, at the owner's expense. If replacement packaging materials are required, they may be purchased from the factory at a charge. **Returned products must be accompanied by a written description of the defect, and a return authorization number (available from the factory via phone or email).**

Upon receipt of defective product, Alfred & Partners OÜ agrees to repair the product without charge for parts or labour. The product will then be returned via prepaid, insured freight, with carrier at the

sole determination of Alfred & Partners OÜ. This constitutes the purchaser's sole remedy.

Alfred & Partners OÜ undertakes during the warranty period to the exclusion of any other remedy to repair or replace the part of the product, which the examination by Alfred & Partners OÜ shows to have been defective. Warranty period for repaired or replaced parts shall not exceed the original warranty period and shall terminate along with the original warranty. The term of the original warranty shall not be extended by the duration of any warranty repairs.

5. Design Changes – ESTELON reserves the right to modify its products or change specifications at any time without obligation or liability to previous purchasers.

6. Miscellaneous – This warranty does not extend to any incidental or consequential costs or damages to the purchaser. This warranty gives you specific legal rights. You may also have other rights which vary from country to country.

Instructions for Obtaining Repair Service

1. Complete the Return Authorization Request Form – available online at estelon.com/support.
2. Upon clicking the 'Submit' button on the Return Authorization Form, the ESTELON factory will review it for completeness and return an e-mail to you with an RA number when required (please allow 2-5 days for a return e-mail).
3. Crate and / or package the product **in its ORIGINAL FLIGHT CASE CONTAINERS ONLY**, according to the instructions included in the return e-mail, and ship the product to the shipping address included in the e-mail. The owner is responsible for paying the shipping and insurance charges (Alfred & Partners OÜ will cover return shipping and insurance charges on warranty repairs).

4. In the case of non-warranty repairs, Alfred & Partners OÜ will physically inspect the product and contact the customer for repair approval. Upon approval and completion of repair, the product owner will be informed of the final charges (including return shipping). Payment may be made by bank / wire transfer prior to final shipment). Payments not received within 30 days of initial contact may incur storage fees.



We strongly recommend that all product repairs should be conducted through the ESTELON factory or an authorized ESTELON repair facility. ESTELON products are designed and manufactured to the highest tolerances with numerous hand-picked components; for this reason, we HIGHLY RECOMMEND that components not be serviced by non-authorized repair facilities. Alfred & Partners OÜ values its loyal customers and will make every attempt to return repaired products to their original factory specifications. Customers should consult with their original ESTELON dealer or distributor for possible alternate repair instructions prior to contacting the ESTELON factory. BUT under any and all circumstances customers are welcome to contact our sales department, as listed on our web site www.estelon.com, for service assistance. All non warranty repairs are warranted for one year from date of return shipment.



*Have we answered all your questions?
If not, please send us an email with your questions to
sales@estelon.com*

www.estelon.com

ESTELON is a trademark of Alfred & Partners OÜ

Alfred & Partners OÜ

Mõisa 4

13522 Tallinn

Estonia

Notes